

Calibration gas cylinders

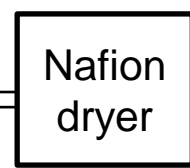

7 L min⁻¹

Synthetic open-path air-sampling system (S-OPS)

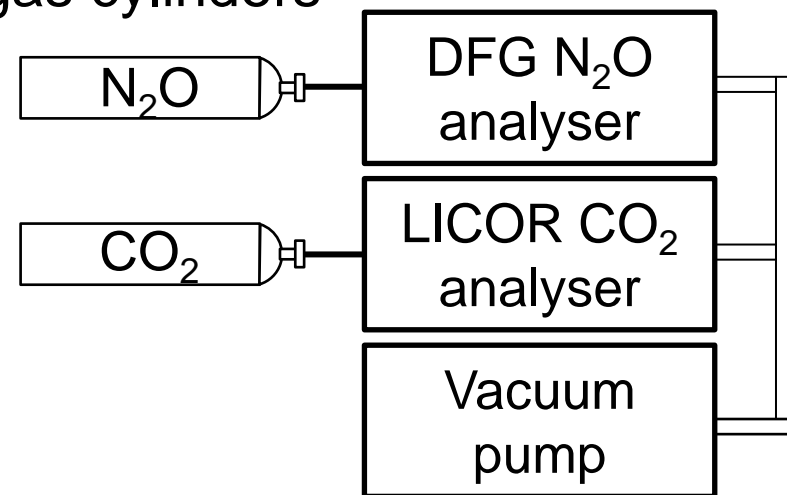
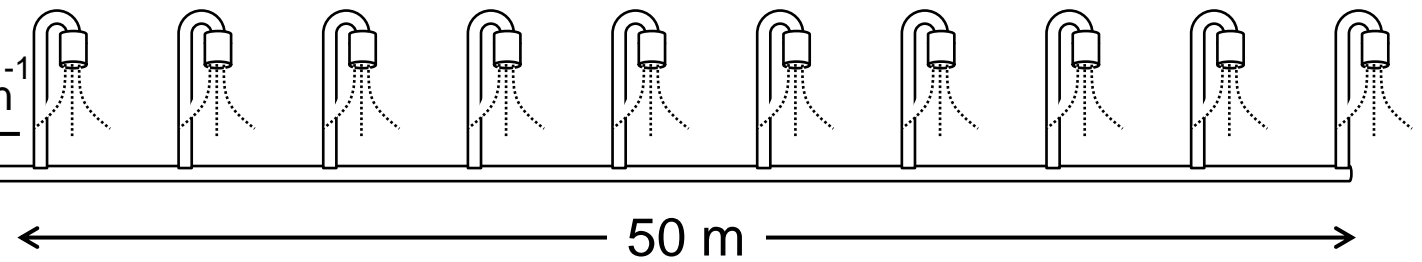

Weather station

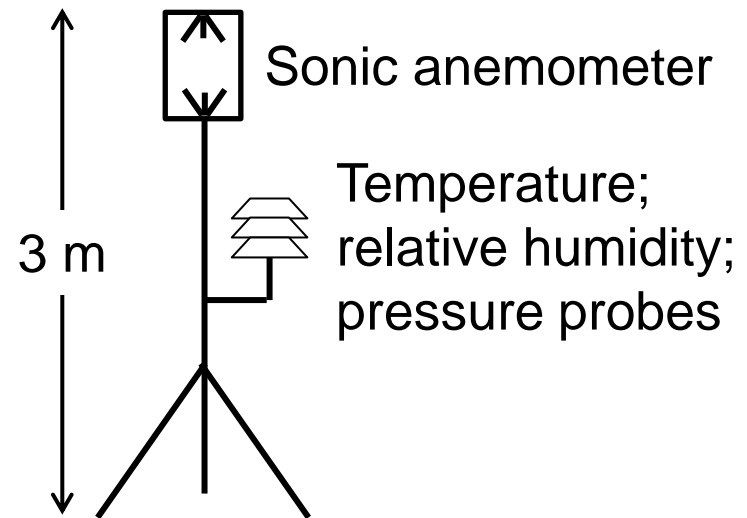

Monostatic OP-FTIR

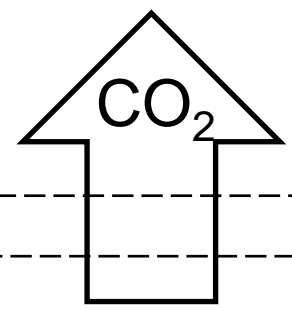
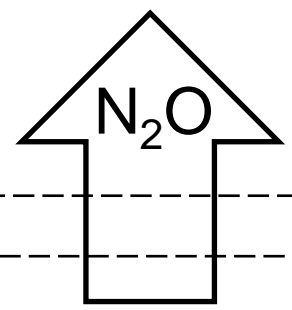
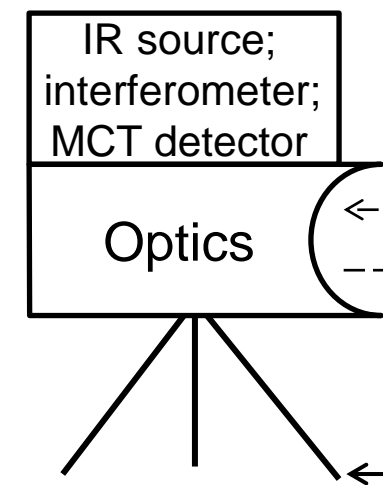

Retroreflector

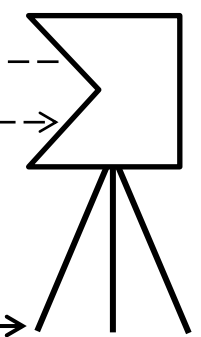

150 m